

FEATURES

- V_{CEsat} with positive temperature coefficient
- Low V_{CEsat}
- Low inductance case
-
- Isolated copper baseplate using DBC technology

Preliminary Data

$V_{CES} = 1200V$

$I_C \text{ nom} = 10A / I_{CRM} = 20A$

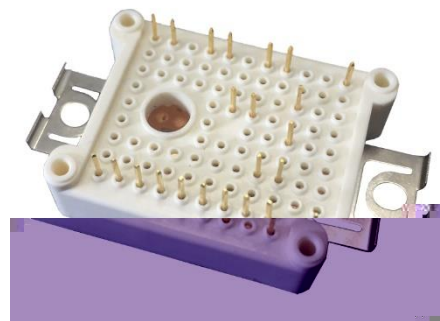

APPLICATION

- Motor drivers
- Air Conditioning
- Auxiliary inverters

Equivalent Circuit Schematic

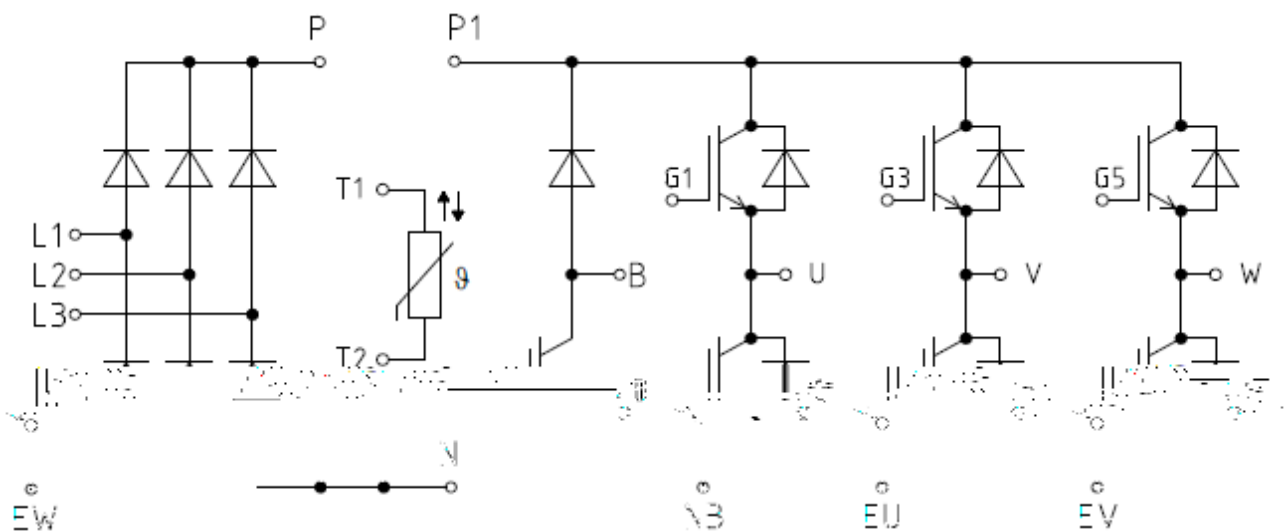

IGBT, Inverter
Maximum Rated Values

l g n l	i h ãi hm	Msg i f	P fo m	Ohæm
-	25		1200	
	100 , 1 5		10	
	1		20	
	25 , 1 5		123	
-			20	

Characteristic Values

l g n l	i h ãi hm	Msg i f	P fo m			Ohæm
			G ð(s (G r(
-	10 , 10 25 150			1.5 2.10		
	1.5 , 25			.1		

Diode, Inverter

Maximum Rated Values

l g n l	i h ǎ hm	M s g i f	P f o m	O h ǎ m
	25		1200	
			10	
	1		20	

Characteristic Values

l g n l	i h ǎ hm	M s g i f	P f o m			O h ǎ m
			G ǎ (s (G r (
	10 , 0 25			1.		
	10 , - / 00 / 00 , -15 / 25			1		
				1.		
				0.35		
,				1.24	1.4	/
,	1 / (·) / 1 / (·)			1.2		/
			-40		150	

Diode, Rectifier

Maximum Rated Values

l g n l	i h ǎ hm	M s g i f	P f o m	O h ǎ m
---------	----------	-----------	---------	---------

IGBT, Brake-Chopper Maximum Rated Values

l g n l

Module

Maximum Rated Values

Symbol	Parameter	Unit	Value	Notes
	Rated current	A	2.5	
	Rated power	W	20	
	Rated voltage	V	11.5	
	Rated speed	rpm	3000	
	Rated torque	Nm	10	
	Rated load	kg	5	
	Rated life	h	200	

Characteristic Values

Symbol	Parameter	Unit	Value	Notes
--------	-----------	------	-------	-------

Input Characteristics

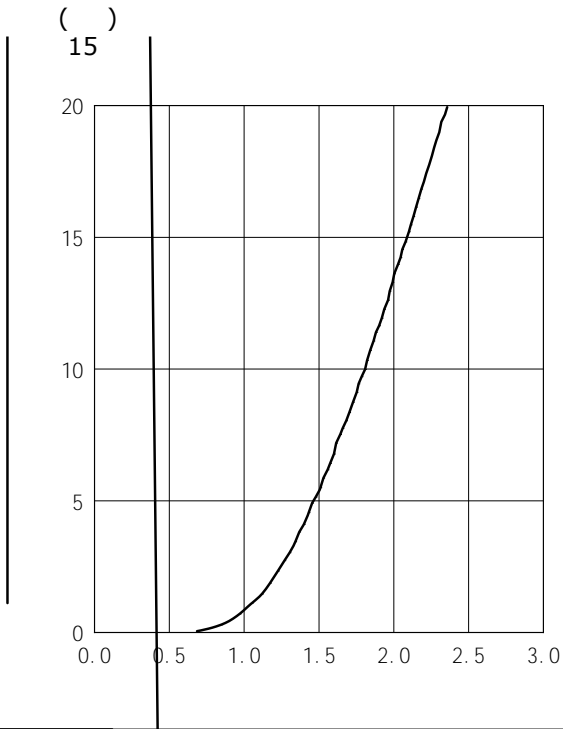

Output Characteristics

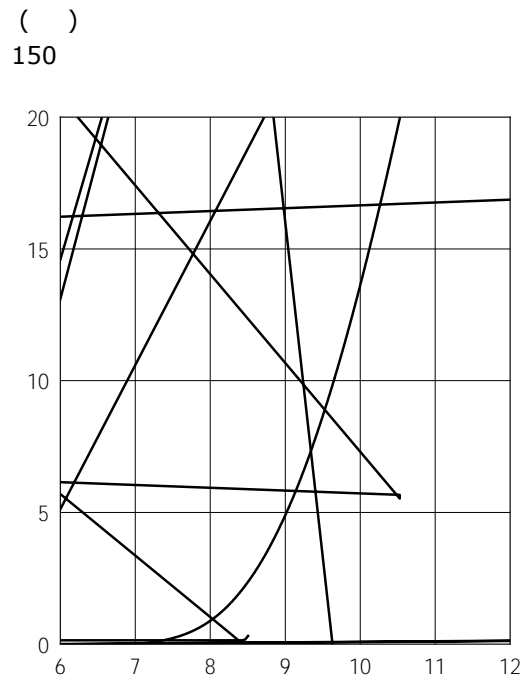

Transfer Characteristics

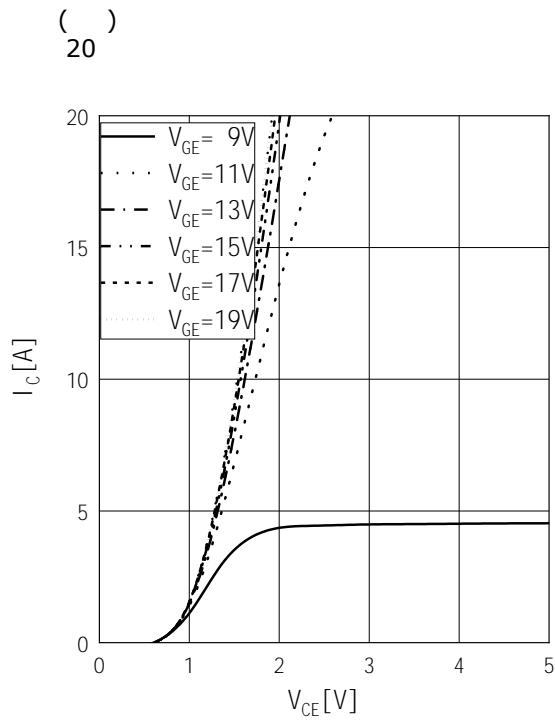

Dynamic Characteristics

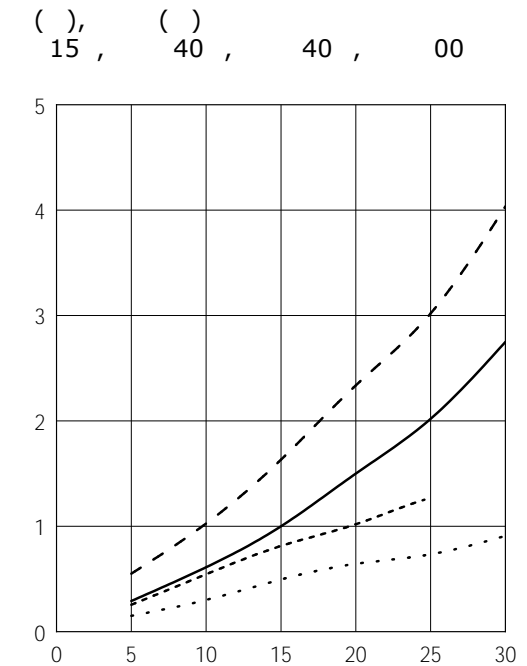

Module Parameter Chart Chip Parameter Chart

Module Parameter Chart Chip Parameter Chart

(), ()
15, 10, 00

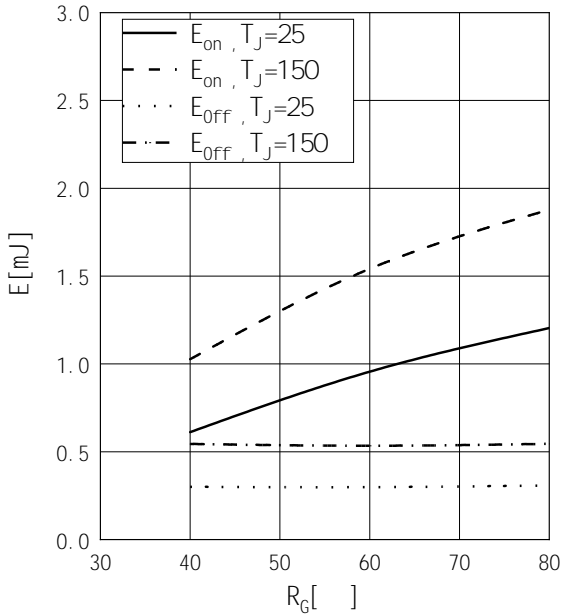

(), ()
15, 34, 150

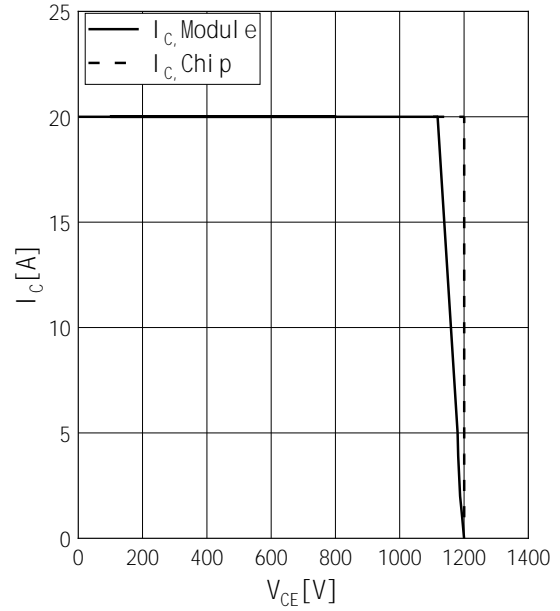

Module Parameter Chart Chip Parameter Chart

()

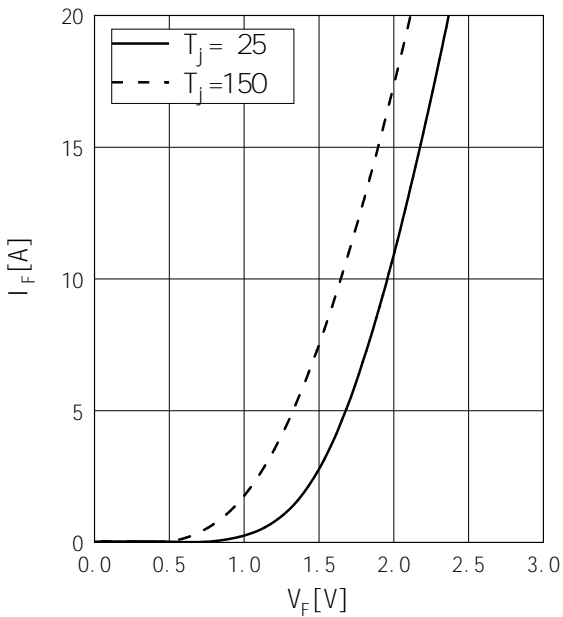

()
3, 00

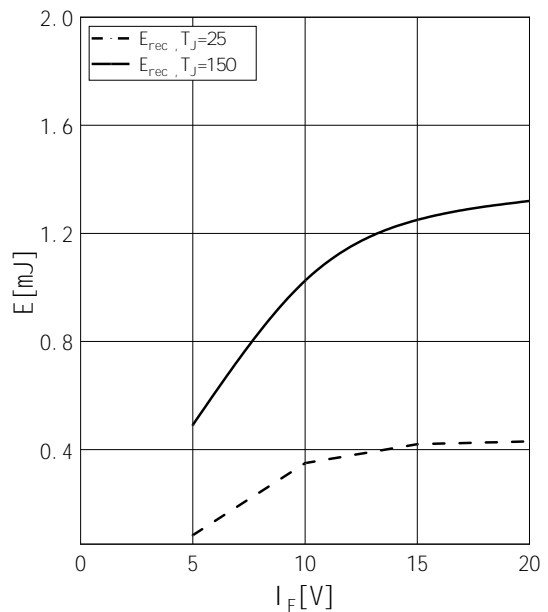

Maximum Recurrent Energy (mJ)

()
15, 00

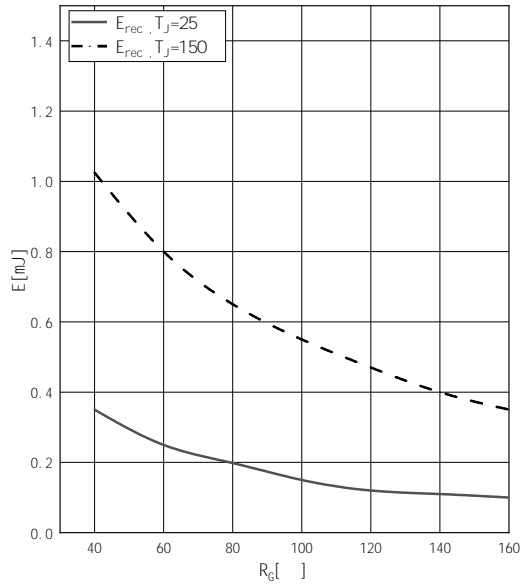

Forward Current (A)

()

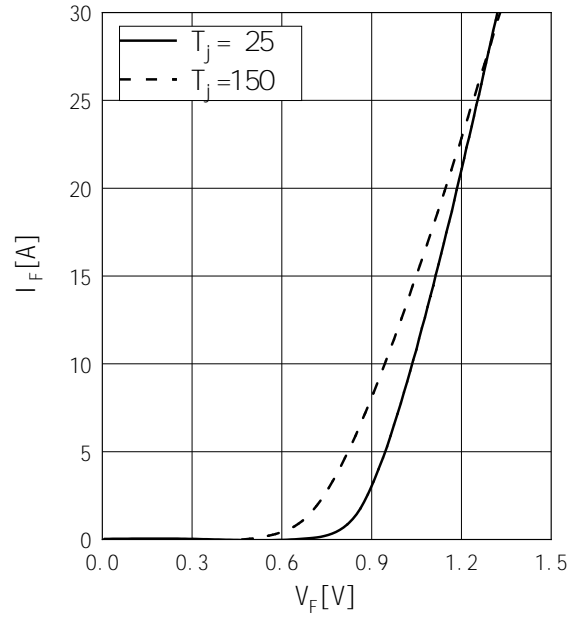

On-state Voltage (V)

()
15

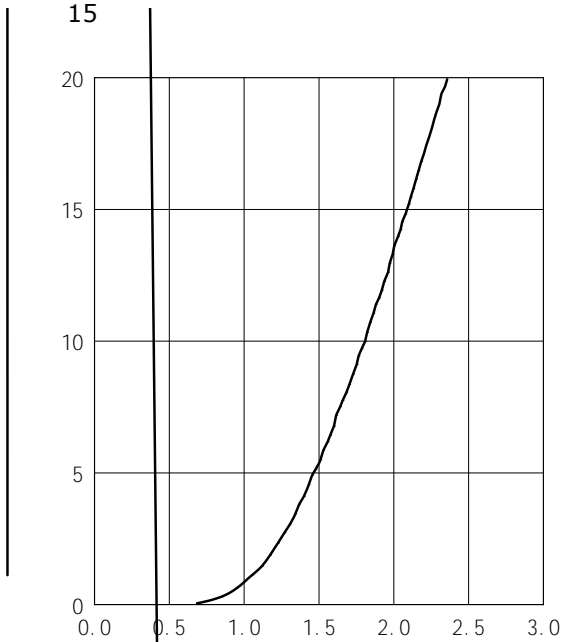

Forward Current (A)

()

